

T3C

# PRODUCT INSTALLATION GUIDE

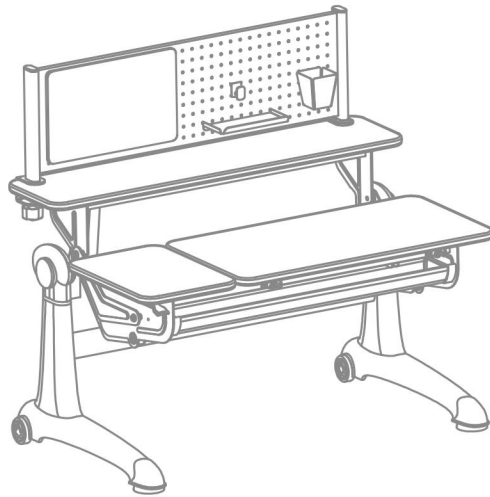











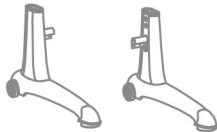
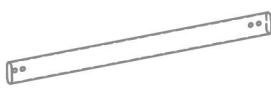
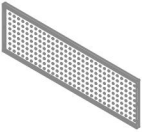
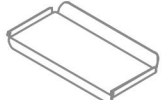

Product Size:111\*75\*102CM

If you are still confused after reading the installation guide, we apologize for it, please follow our Facebook homepage--Sihoo chair, and contact us, we will send you a video to help you install. wish you a happy life!

 Note!only adults are allowed to install, keep children away

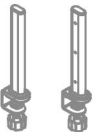
## Accessories list (subject to actual size, each type of screw has extra for spare, unit: piece/set)

 Note! all accessories , prevent children from swallowing

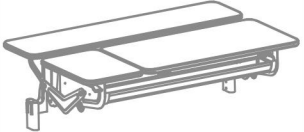
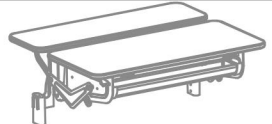
 table legs*2	 table leg crossbar*1	 steel screen backplane*1
 storage pocket*1	 decorative cover*2	 storage hook*1
 M8*12 screw*5	 pen holder*1	 M6*14 screw*7
 hex wrench*1	 felt panel *1	 M6*20 screw*9
 bookshelf bracket*2	 small round cover*2	 3M double-sided tape*5
 Phillips screwdriver*1	 round magnet*5	
optional accessories	 1.1 m desktop frame assembly*1	 0.9 m desktop frame assembly*1



## Installation diagram (subject to actual size)

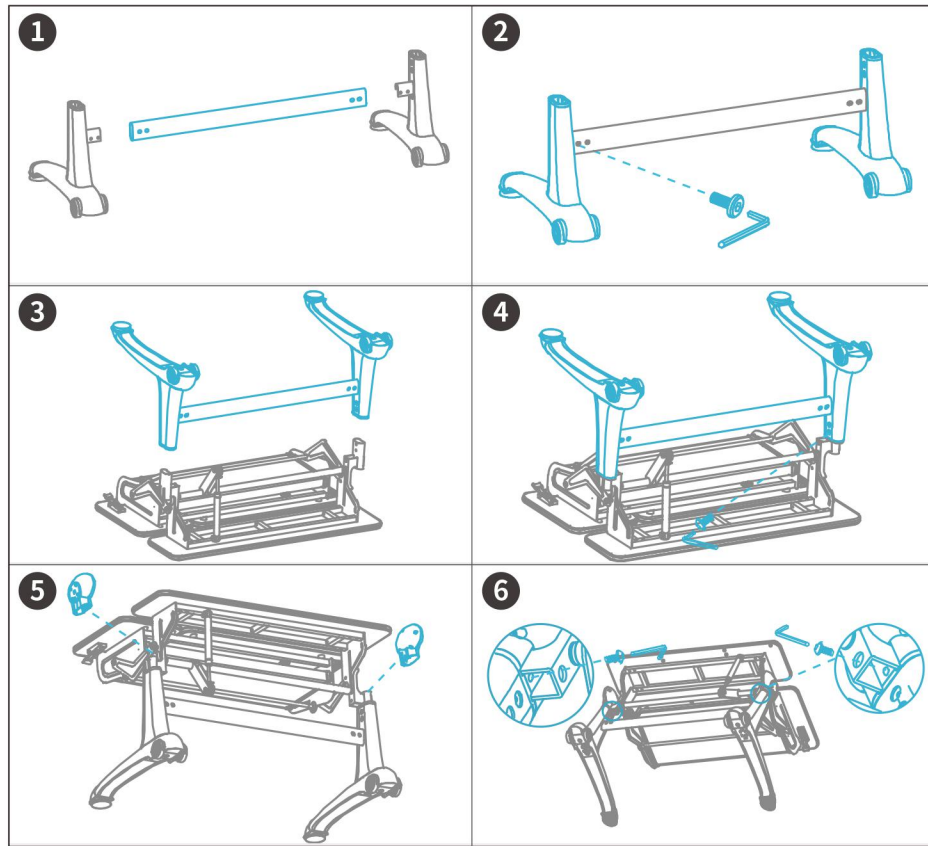

1. Set the crossbar of the table leg to the table leg;
2. Use 4 M8\*12 screws to fix the table leg crossbar and the table leg;
3. Place the desktop shelf assembly face down (pay attention to protect the surface of the panel), and then reverse the installed tripod and align it with the oval tube.
4. Use 4 M6\*20 screws to fix the table leg and the table top frame assembly;
5. Align the decorative cover with the oval tube and insert it, paying attention to the left and right points;
6. Use two M6\*20 screws to lock the decorative cover on the desktop frame assembly;

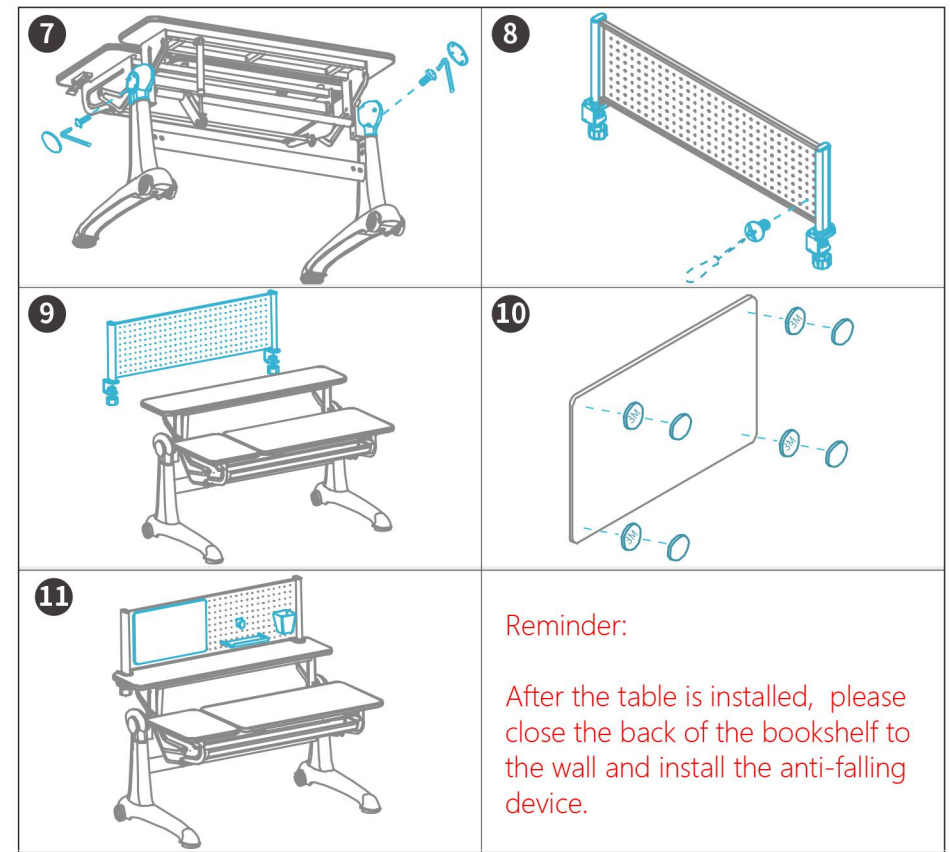

### Reminder:

After the table is installed, please close the back of the bookshelf to the wall and install the anti-falling device.

7. Use two 6\*20 screws to lock the decorative cover on the desktop frame assembly, and then align the small round cover with the positioning hole of the decorative cover and press it in;
8. Use 6 M6\*14 screws to fix the steel screen backplane with the bookshelf bracket;
9. Put the installed steel screen board assembly on the desktop board, adjust the appropriate position, and tighten the fastening knob;
10. (1) First paste the 3M double-sided tape on the round magnet;  
(2) Attach the round magnets to the four corners of the felt board;
11. Align the hook hole to install the storage pocket, pen holder, storage hook, and felt panel. Attach it to the back panel of the steel screen and adjust the appropriate position. Finally, according to the floor level, adjust the height of the foot pad appropriately.