

T1

# PRODUCT INSTALLATION GUIDE



Product Size: 105\*80\*100CM











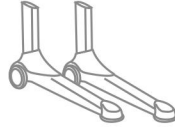

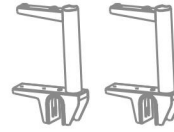
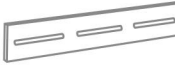

Note ! only adults are allowed to install, keep children away

 Note ! all accessories , prevent children from swallowing

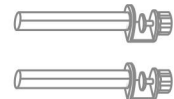
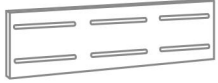
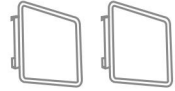

Accessories list (subject to actual size, each type of screw has extra for spare, unit: piece/set)

		
Desktop*1	Table leg*2	Partition *1
		
Lower bracket*2	Lower baffle*1	Hex wrench*2
		
M6*20 screw*7	M6*10 screw*5	M6*12 screw*5
		
Bookshelf panel*1	Wing nut*5	
		
Upper bracket*2	Upper baffle*1	Book end*2
		
Brush tube*1	Stationery box*1	Color tiles*6

## Installation diagram ( subject to actual size )

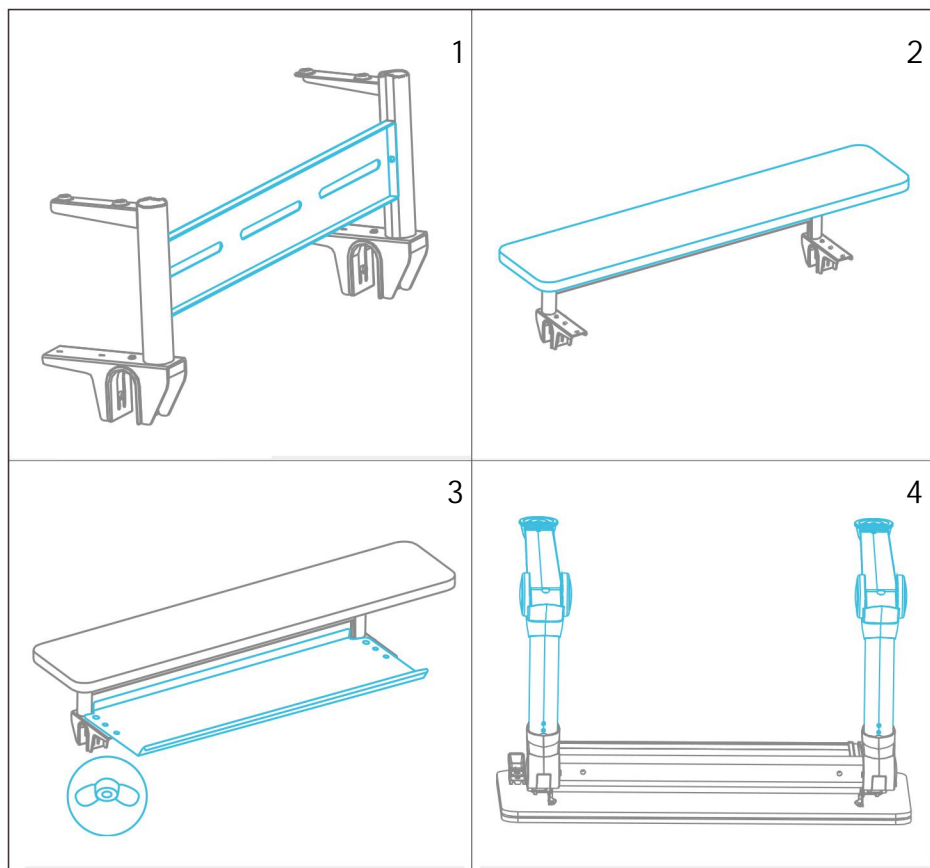

1. When installing the lower baffle first: use two M6\*10 screws to install the lower baffle to the lower bracket;

2. When installing the bookshelf panel: use four M6\*20 screws to install the bookshelf panel to the lower bracket;

3. When installing the partition, the partition directly passes through the hole of the lower bracket, and the partition is tightened to the lower bracket with 4 wing nuts;

4. When installing the table legs, insert the table legs directly into the holes of the desktop, and install the table legs on the desktop with 4 M6\*12 screws;

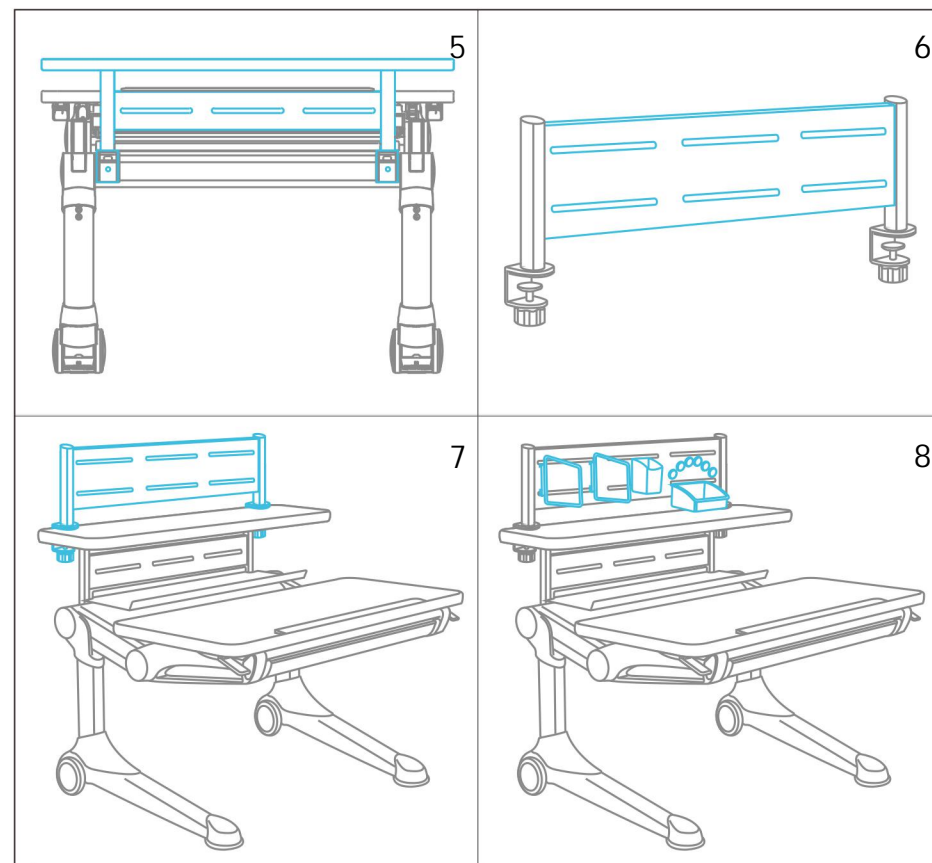

5. When the lower bracket is placed on the desktop, use two M6\*20 screws to install the lower bracket on the desktop;

6. When installing the upper baffle, insert the upper baffle directly into the groove of the upper bracket, and install the upper baffle to the upper bracket with 2 M6\*10 screws;

7. Use the knob to install the upper bracket on the bookcase panel and tighten it;

8. When the other bookshelf accessories are installed on the baffle, the installation is complete.

**Reminder:** After the table is installed, please close the back of the bookshelf to the wall and install the anti-falling device.