

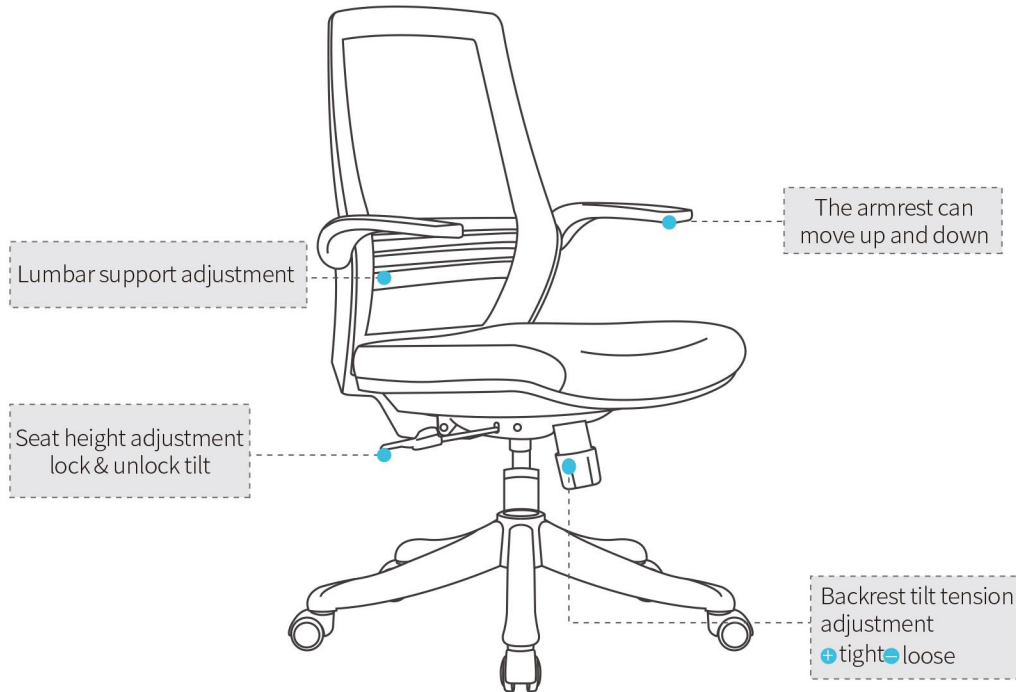





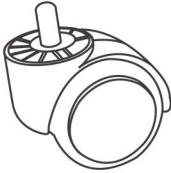
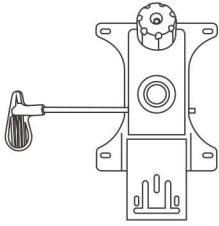
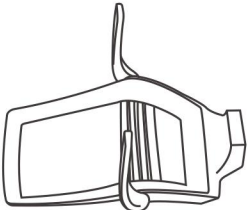

# PRODUCT INSTALLATION GUIDE

## M59-D

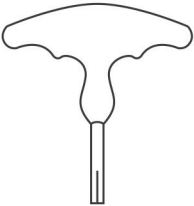

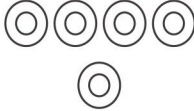
62\*55\*90(98)CM

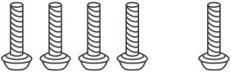
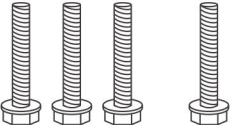
## Parts list (According to the actual size; each type of screw and gasket have a spare)

		
Castores*5 pcs	Mechanism *1 pc	Backrest*1 pc
		
Seat cushion*1 pc	Hex wrench*1 pc	Gas lift*1 pcs
		
Big shim 3+1 pcs	Samll shim 4+1 pcs	Base*1 pc
		
mechanism screw(M6*25)4+1pcs	Back screw(M8*40)3+1pcs	
		

**Note:** before installing the chair, please sort the screws and measure the screw length for installation.

# Installation diagram (subject to actual size)

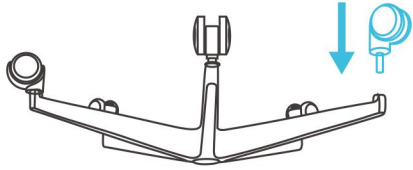

**1** Put the castor into the base by pressing.

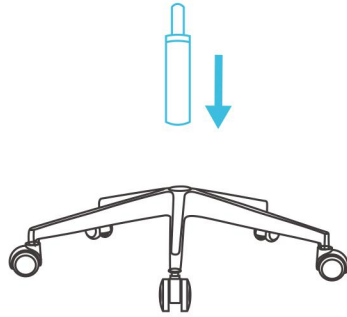

**2** Insert the gaslift to the base.

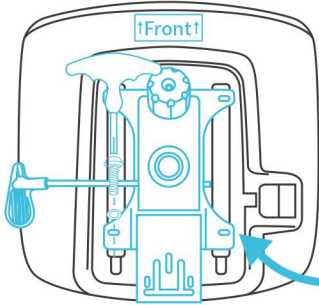

Due to the need of sliding, the mechanism screw cannot be tightened by force at once, Otherwise, the adjustment function will be affected.

**3** Fix the mechanism to the seat cushion with 4pcs(M6\*25)screws and 4pcs small shim. Pay attention to the front and back.

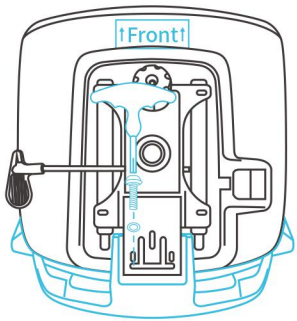

**4** Fix the backrest to the seat cushion with 3pcs(M8\*40)screws and 3pcs big shim screws.



**5** Put the upper part of chair to the gas lift.