

H5C











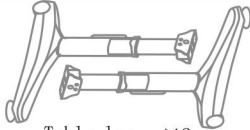

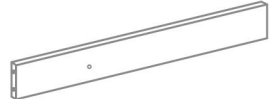



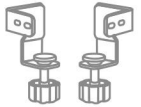

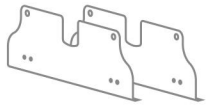
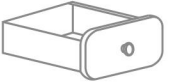



Installation procedure



Accessories list (Subject to the actual size; each type of screw is equipped with extra spare screws; Unit: piece / set)

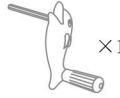

NOTE! All accessories, please be careful not to be swallowed by children

 <p>Table leg ×2</p>		 <p>Desktop board ×1</p>		 <p>Upper and lower back plates of bookshelf ×2</p>	
 <p>Lower baffle ×1</p>		 <p>Hexagon bar ×1</p>		 <p>Large laminate ×1</p>	
 <p>Bookshelf side panel ×3</p>		 <p>Left and right bookshelf corner ×2</p>		 <p>Small laminate ×1</p>	
 <p>Plastic drawer ×1</p>		 <p>Drawer bracket ×4</p>		 <p>Woodern drawer ×1</p>	
 <p>M3*35 Screw ×3</p>	 <p>M6*14 Screw ×23</p>	 <p>M6*30 Screw ×5</p>	 <p>M4*10 Screw ×3</p>	 <p>Taper nut ×5</p>	 <p>Screw arbor ×20</p>
 <p>Book Bar ×1</p>		 <p>Look handle ×15</p>	 <p>Reading stand ×1</p>	 <p>Rubber plug ×2</p>	 <p>Lifiting adjustable ×1</p>
 <p>Hook ×1</p>		 <p>Cross screwdriver ×1</p>		<p>Install video</p> 	

# 安装图示 (以实际大小为准)

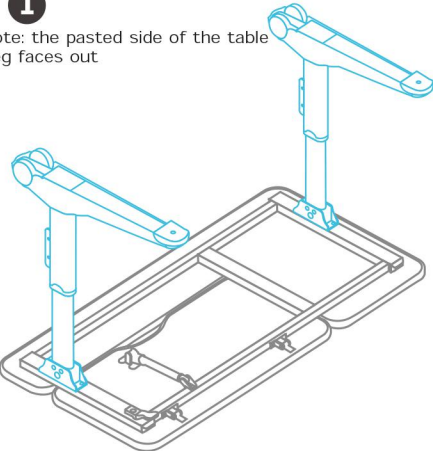
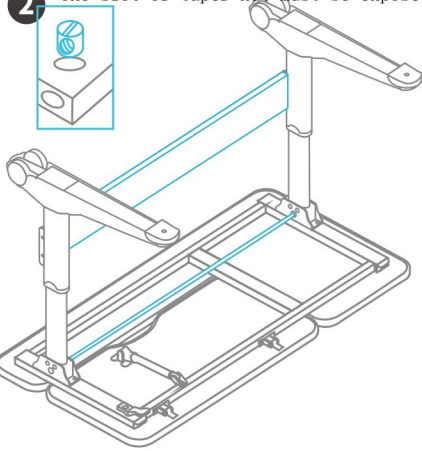
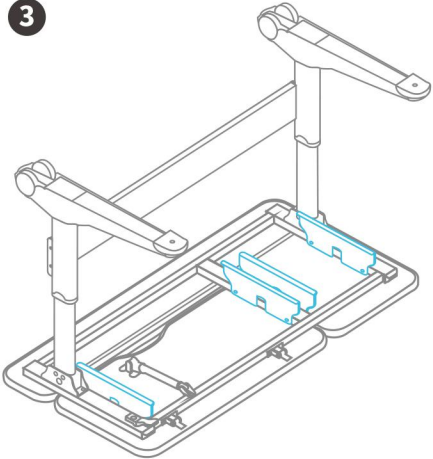
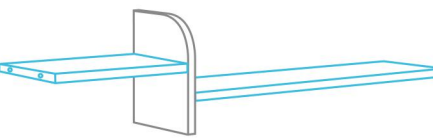
<p><b>1</b></p> <p>Note: the pasted side of the table leg faces out</p>  <p>Use 8 M6*14 screws to install the left and right table legs on the table board (Keep the table leg and handle in the same direction)</p>	<p><b>2</b> The slot of taper nut must be exposed</p>  <p>1. Insert the hexagon strip into the hexagon hole of the left and right table legs (The fixings can be loosened) 2. Put 4 taper nuts into the lower baffle of table leg 3. Screw down 4 screws (M6 * 30) on the cone nut (Note: The lower baffle plate is facing forward)</p>
<p><b>3</b></p>  <p>Use 4 screws (M6*14) to install the drawer bracket on the desktop board assembly. Note: 1. Must to match installation 2. The pull out direction of guide rail is consistent with that of hinge</p>	<p><b>4</b></p>  <p>1. Install screws on each plate 2. Tighten the large and small laminates to the middle side plate with the lock handle</p>

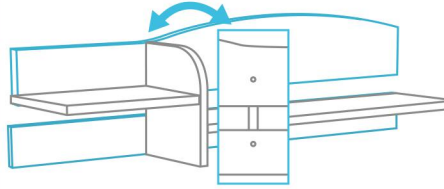
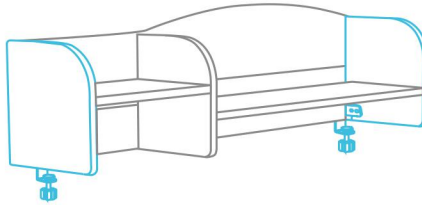
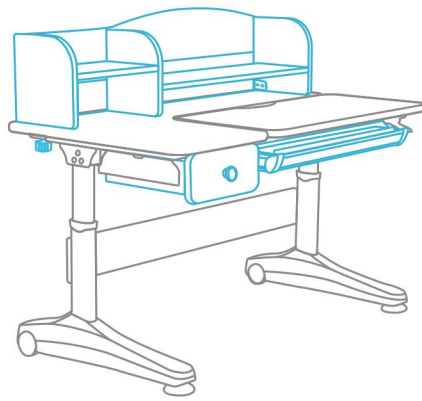
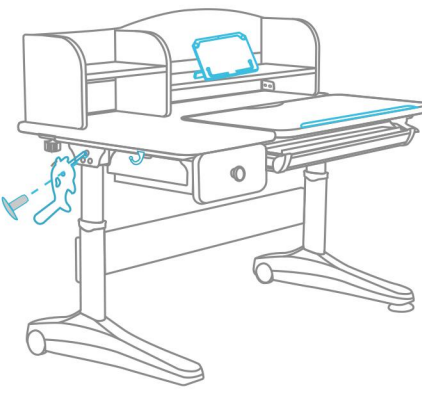
<p><b>5</b></p>  <p>Use M3*35 screws, screws arbor and lock handles to install the large and small laminates and middle side plates to the upper and lower back plates</p>	<p><b>6</b></p>  <p>1. Install the left and right side panels and tighten the locking handles 2. Use 4 M6*14 screws to install the left and right bookshelf corner codes on the bookshelf side plate and tighten them</p>
<p><b>7</b></p>  <p>Put the bookshelf on the desktop, tighten the bookshelf knob; Warm tips: The large bookshelf should be against the wall and insert the wooden drawer and plastic drawer into the guide rail at the same time,</p>	<p><b>8</b></p>  <p>1. Use two M4 * 10 screws to install the hook on the desktop assembly Put two rubber plugs into the holes to be handled Place the reading stand and the book bar, and assemble the table</p>